





Morse Table

Dimension Guide







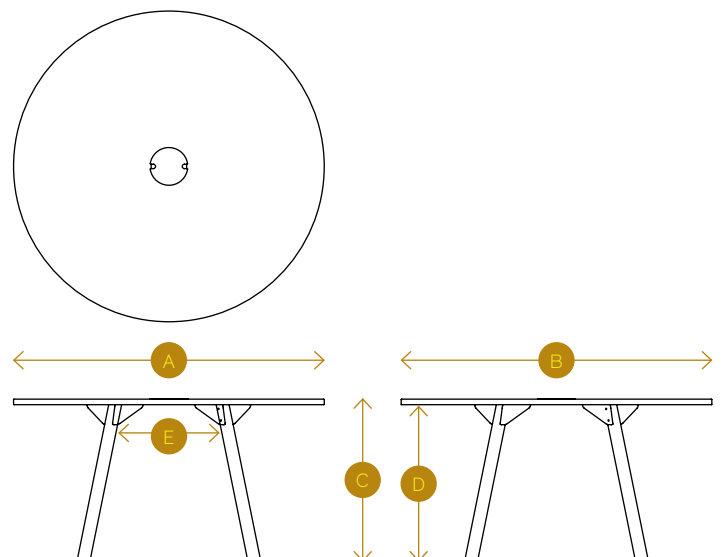

Circular Tables

PRODUCT CODE/ DESCRIPTION	A OVERALL WIDTH	B OVERALL DEPTH	C OVERALL HEIGHT	D FLOOR TO TABLE TOP	E DISTANCE BETWEEN LEGS	F WEIGHT	G CAD
NOMS0312							
Morse Circular Table dia 1200	1200 mm 47 in	1200 mm 47 in	730 mm 28.5 in	705 mm 28 in	285 mm 11 in	36 kg 79.5 lb	
NOMS0314							
Morse Circular Table dia 1400	1400 mm 55 in	1400 mm 55 in	730 mm 28.5 in	705 mm 28 in	430 mm 17 in	44.5 kg 98 lb	
NOMS0512							
Morse Bar Height Circular Table dia 1200	1200 mm 47 in	1200 mm 47 in	1050 mm 41.5 in	1025 mm 40.5 in	285 mm 11 in	40 kg 88 lb	
NOMS0514							
Morse Bar Height Circular Table dia 1400	1400 mm 55 in	1400 mm 55 in	1050 mm 41.5 in	1025 mm 40.5 in	430 mm 17 in	48 kg 106 lb	

Measuring Guide



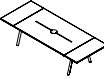





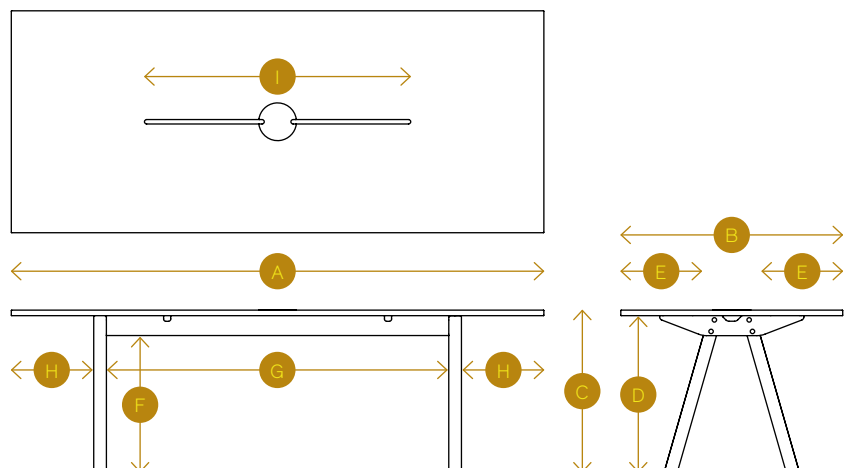

Meeting Tables

PRODUCT CODE/ DESCRIPTION	A OVERALL WIDTH	B OVERALL DEPTH	C OVERALL HEIGHT	D FLOOR TO TABLE TOP	E FRONT OF TOP TO BEAM	F FLOOR TO BEAM	G DIS- TANCE BETWEEN LEGS	H SIDE OF TOP TO BRACE	I ACCES- SORIES CHANNEL	J WEIGHT	K CAD
NOMSB320R											
Morse Rectangular Meeting Table w2000 x d1000	2000 mm 78.5 in	1000 mm 39.5 in	730 mm 28.5 in	705 mm 28 in	360 mm 14 in	615 mm 24 in	1145 mm 45 in	370 mm 14.5 in	N/A	63 kg 139 lb	
NOMSB324R											
Morse Rectangular Meeting Table w2400 x d1000	2400 mm 94.5 in	1000 mm 39.5 in	730 mm 28.5 in	705 mm 28 in	360 mm 14 in	615 mm 24 in	1545 mm 61 in	370 mm 14.5 in	1200 mm 47 in	74 kg 163 lb	
NOMSB330R											
Morse Rectangular Meeting Table w3000 x d1000	3000 mm 118 in	1000 mm 39.5 in	730 mm 28.5 in	705 mm 28 in	360 mm 14 in	615 mm 24 in	1945 mm 76.5 in	470 mm 18.5 in	1400 mm 55 in	97 kg 214 lb	
NOMSB330D											
Morse Radius Corner Meeting Table w3000 x d1000	3000 mm 118 in	1000 mm 39.5 in	730 mm 28.5 in	705 mm 28 in	360 mm 14 in	615 mm 24 in	1945 mm 76.5 in	470 mm 18.5 in	1400 mm 55 in	97 kg 214 lb	
NOMSC320R											
Morse Rectangular Meeting Table w2000 x d1200	2000 mm 78.5 in	1200 mm 47 in	730 mm 28.5 in	705 mm 28 in	385 mm 15 in	615 mm 24 in	1145 mm 45 in	370 mm 14.5 in	N/A	73 kg 161 lb	
NOMSC324R											
Morse Rectangular Meeting Table w2400 x d1200	2400 mm 94.5 in	1200 mm 47 in	730 mm 28.5 in	705 mm 28 in	385 mm 15 in	615 mm 24 in	1545 mm 61 in	370 mm 14.5 in	1200 mm 47 in	85.5 kg 188.5 lb	
NOMSC330R											
Morse Rectangular Meeting Table w3000 x d1200	3000 mm 118 in	1200 mm 47 in	730 mm 28.5 in	705 mm 28 in	385 mm 15 in	615 mm 24 in	1945 mm 76.5 in	470 mm 18.5 in	1400 mm 55 in	111 kg 245 lb	
NOMSC330D											
Morse Radius Corner Meeting Table w3000 x d1200	3000 mm 118 in	1200 mm 47 in	730 mm 28.5 in	705 mm 28 in	385 mm 15 in	615 mm 24 in	1945 mm 76.5 in	470 mm 18.5 in	1400 mm 55 in	111 kg 245 lb	

Measuring Guide





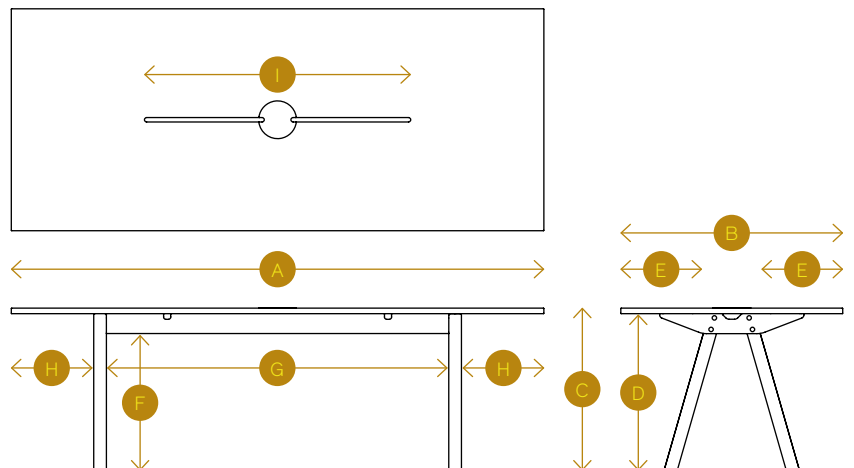

Bar Height Meeting Tables

PRODUCT CODE/ DESCRIPTION	A OVERALL WIDTH	B OVERALL DEPTH	C OVERALL HEIGHT	D FLOOR TO TABLE TOP	E FRONT OF TOP TO BEAM	F FLOOR TO BEAM	G DIS- TANCE BETWEEN LEGS	H SIDE OF TOP TO BRACE	I ACCES- SORIES CHANNEL	J WEIGHT	K CAD
NOMSB520R											
Morse Bar Height Rectangular Meeting Table w2000 x d1000	2000 mm 78.5 in	1000 mm 39.5 in	1050 mm 41.5 in	1025 mm 40.5 in	360 mm 14 in	935 mm 37 in	1145 mm 45 in	370 mm 14.5 in	N/A	66.5 kg 146.5 lb	
NOMSB524R											
Morse Bar Height Rectangular Meeting Table w2400 x d1000	2400 mm 94.5 in	1000 mm 39.5 in	1050 mm 41.5 in	1025 mm 40.5 in	360 mm 14 in	935 mm 37 in	1545 mm 61 in	370 mm 14.5 in	1200 mm 47 in	77.5 kg 171 lb	
NOMSB530R											
Morse Bar Height Rectangular Meeting Table w3000 x d1000	3000 mm 118 in	1000 mm 39.5 in	1050 mm 41.5 in	1025 mm 40.5 in	360 mm 14 in	935 mm 37 in	1945 mm 76.5 in	470 mm 18.5 in	1400 mm 55 in	100.5 kg 221.5 lb	
NOMSB530D											
Morse Bar Height Radius Corner Meeting Table w3000 x d1000	3000 mm 118 in	1000 mm 39.5 in	1050 mm 41.5 in	1025 mm 40.5 in	360 mm 14 in	935 mm 37 in	1945 mm 76.5 in	470 mm 18.5 in	1400 mm 55 in	100.5 kg 221.5 lb	
NOMSC520R											
Morse Bar Height Rectangular Meeting Table w2000 x d1200	2000 mm 78.5 in	1200 mm 47 in	1050 mm 41.5 in	1025 mm 40.5 in	385 mm 15 in	935 mm 37 in	1145 mm 45 in	370 mm 14.5 in	N/A	76.5 kg 168.5 lb	
NOMSC524R											
Morse Bar Height Rectangular Meeting Table w2400 x d1200	2400 mm 94.5 in	1200 mm 47 in	1050 mm 41.5 in	1025 mm 40.5 in	385 mm 15 in	935 mm 37 in	1545 mm 61 in	370 mm 14.5 in	1200 mm 47 in	89 kg 196 lb	
NOMSC530R											
Morse Bar Height Rectangular Meeting Table w3000 x d1200	3000 mm 118 in	1200 mm 47 in	1050 mm 41.5 in	1025 mm 40.5 in	385 mm 15 in	935 mm 37 in	1945 mm 76.5 in	470 mm 18.5 in	1400 mm 55 in	114.5 kg 252.5 lb	
NOMSC530D											
Morse Bar Height Radius Corner Meeting Table w3000 x d1200	3000 mm 118 in	1200 mm 47 in	1050 mm 41.5 in	1025 mm 40.5 in	385 mm 15 in	935 mm 37 in	1945 mm 76.5 in	470 mm 18.5 in	1400 mm 55 in	114.5 kg 252.5 lb	

Measuring Guide





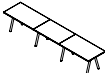
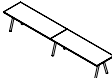
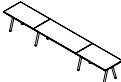
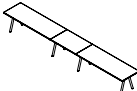
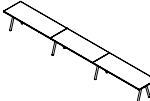

Work Tables depth 800 mm / 31.5 in

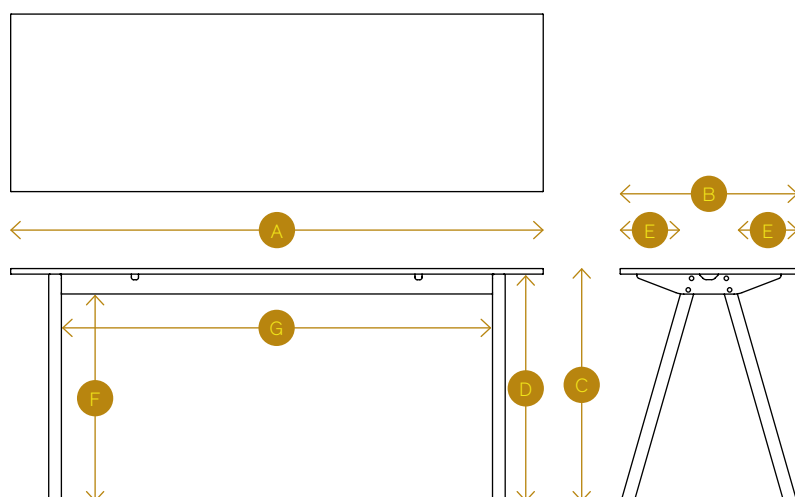
PRODUCT CODE/ DESCRIPTION	A OVERALL WIDTH	B OVERALL DEPTH	C OVERALL HEIGHT	D FLOOR TO TABLE TOP	E FRONT OF TOP TO BEAM	F FLOOR TO BEAM	G DISTANCE BETWEEN LEGS	H WEIGHT	I CAD
NOMSAC316									
Morse Work Table w1600 x d800	1600 mm 63 in	800 mm 31.5 in	730 mm 28.5 in	705 mm 28 in	260 mm 10 in	615 mm 24 in	1145 mm 45 in	48 kg 106 lb	
NOMSAC324									
Morse Work Table w2400 x d800	2400 mm 94.5 in	800 mm 31.5 in	730 mm 28.5 in	705 mm 28 in	260 mm 10 in	615 mm 24 in	1945 mm 76.5 in	64 kg 141 lb	
NOMSAG328									
Morse Work Table w2800 x d800	2800 mm 110 in	800 mm 31.5 in	730 mm 28.5 in	705 mm 28 in	260 mm 10 in	615 mm 24 in	2345 mm 92.5 in	83 kg 183 lb	
NOMSAG336									
Morse Work Table w3600 x d800	3600 mm 141.5 in	800 mm 31.5 in	730 mm 28.5 in	705 mm 28 in	260 mm 10 in	615 mm 24 in	3145 mm 124 in	98.5 kg 217 lb	
NOMSAG340									
Morse Work Table w4000 x d800	4000 mm 157.5 in	800 mm 31.5 in	730 mm 28.5 in	705 mm 28 in	260 mm 10 in	615 mm 24 in	3545 mm 139.5 in	117.5 kg 259 lb	
NOMSAG344									
Morse Work Table w4400 x d800	4400 mm 173 in	800 mm 31.5 in	730 mm 28.5 in	705 mm 28 in	260 mm 10 in	615 mm 24 in	3945 mm 155.5 in	114 kg 251.5 lb	
NOMSAG348									
Morse Work Table w4800 x d800	4800 mm 189 in	800 mm 31.5 in	730 mm 28.5 in	705 mm 28 in	260 mm 10 in	615 mm 24 in	4345 mm 171 in	133 kg 293.5 lb	
NOMSAG356									
Morse Work Table w5600 x d800	5600 mm 220.5 in	800 mm 31.5 in	730 mm 28.5 in	705 mm 28 in	260 mm 10 in	615 mm 24 in	5145 mm 202.5 in	149 kg 328.5 lb	
NOMSAG364									
Morse Work Table w6400 x d800	6400 mm 252 in	800 mm 31.5 in	730 mm 28.5 in	705 mm 28 in	260 mm 10 in	615 mm 24 in	5945 mm 234 in	164.5 kg 362.5 lb	

Measuring Guide



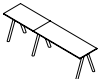
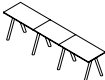
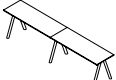
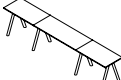
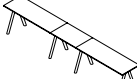

Bar Height Work Tables depth 800 mm / 31.5in

PRODUCT CODE/ DESCRIPTION	A OVERALL WIDTH	B OVERALL DEPTH	C OVERALL HEIGHT	D FLOOR TO TABLE TOP	E FRONT OF TOP TO BEAM	F FLOOR TO BEAM	G DISTANCE BETWEEN LEGS	H WEIGHT	I CAD
NOMSAC516									
Morse Bar Height Work Table w1600 x d800	1600 mm 63 in	800 mm 31.5 in	1050 mm 41.5 in	1025 mm 40.5 in	260 mm 10 in	935 mm 37 in	1145 mm 45 in	52.5 kg 116 lb	
NOMSAC524									
Morse Bar Height Work Table w2400 x d800	2400 mm 94.5 in	800 mm 31.5 in	1050 mm 41.5 in	1025 mm 40.5 in	260 mm 10 in	935 mm 37 in	1945 mm 76.5 in	71 kg 156.5 lb	
NOMSAG528									
Morse Bar Height Work Table w2800 x d800	2800 mm 110 in	800 mm 31.5 in	1050 mm 41.5 in	1025 mm 40.5 in	260 mm 10 in	935 mm 37 in	2345 mm 92.5 in	89.5 kg 197.5 lb	
NOMSAG536									
Morse Bar Height Work Table w3600 x d800	3600 mm 141.5 in	800 mm 31.5 in	1050 mm 41.5 in	1025 mm 40.5 in	260 mm 10 in	935 mm 37 in	3145 mm 124 in	108.5 kg 239 lb	
NOMSAG540									
Morse Bar Height Work Table w4000 x d800	4000 mm 157.5 in	800 mm 31.5 in	1050 mm 41.5 in	1025 mm 40.5 in	260 mm 10 in	935 mm 37 in	3545 mm 139.5 in	127 kg 280 lb	
NOMSAG544									
Morse Bar Height Work Table w4400 x d800	4400 mm 173 in	800 mm 31.5 in	1050 mm 41.5 in	1025 mm 40.5 in	260 mm 10 in	935 mm 37 in	3945 mm 155.5 in	127 kg 280 lb	
NOMSAG548									
Morse Bar Height Work Table w4800 x d800	4800 mm 189 in	800 mm 31.5 in	1050 mm 41.5 in	1025 mm 40.5 in	260 mm 10 in	935 mm 37 in	4345 mm 171 in	145 kg 319.5 lb	
NOMSAG556									
Morse Bar Height Work Table w5600 x d800	5600 mm 220.5 in	800 mm 31.5 in	1050 mm 41.5 in	1025 mm 40.5 in	260 mm 10 in	935 mm 37 in	5145 mm 202.5 in	164 kg 361.5 lb	
NOMSAG564									
Morse Bar Height Work Table w6400 x d800	6400 mm 252 in	800 mm 31.5 in	1050 mm 41.5 in	1025 mm 40.5 in	260 mm 10 in	935 mm 37 in	5945 mm 234 in	183 kg 403.5 lb	

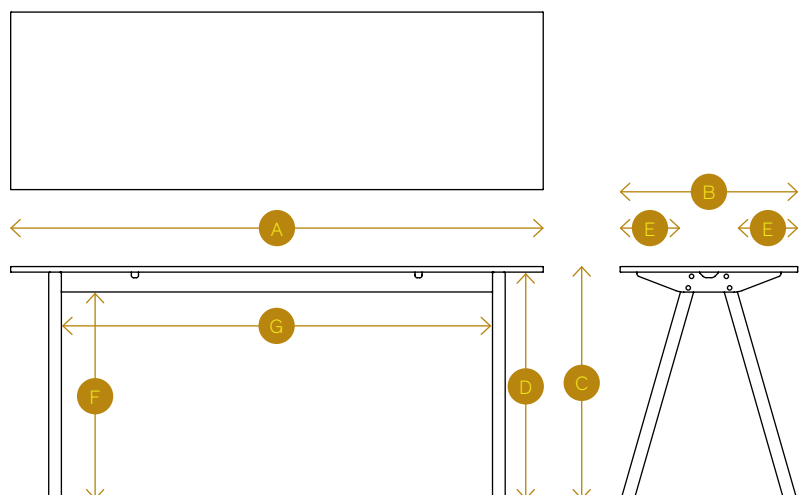
Measuring Guide



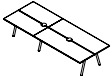
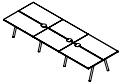
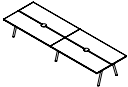
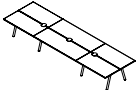
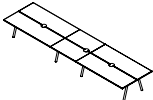
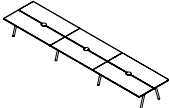

Work Tables depth 1400 mm / 55 in

PRODUCT CODE/ DESCRIPTION	A OVERALL WIDTH	B OVERALL DEPTH	C OVERALL HEIGHT	D FLOOR TO TABLE TOP	E FRONT OF TOP TO BEAM	F FLOOR TO BEAM	G DISTANCE BETWEEN LEGS	H WEIGHT	I CAD
NOMSDC316									
Morse Work Table w1600 x d1400	1600 mm 63 in	1400 mm 55 in	730 mm 28.5 in	705 mm 28 in	410 mm 16 in	615 mm 24 in	1145 mm 45 in	71.5 kg 157.5 lb	
NOMSDC324									
Morse Work Table w2400 x d1400	2400 mm 94.5 in	1400 mm 55 in	730 mm 28.5 in	705 mm 28 in	410 mm 16 in	615 mm 24 in	1945 mm 76.5 in	99.5 kg 219.5 lb	
NOMSDG328									
Morse Work Table w2800 x d1400	2800 mm 110 in	1400 mm 55 in	730 mm 28.5 in	705 mm 28 in	410 mm 16 in	615 mm 24 in	2345 mm 92.5 in	123.5 kg 272.5 lb	
NOMSDG336									
Morse Work Table w3600 x d1400	3600 mm 141.5 in	1400 mm 55 in	730 mm 28.5 in	705 mm 28 in	410 mm 16 in	615 mm 24 in	3145 mm 124 in	151.5 kg 334 lb	
NOMSDG340									
Morse Work Table w4000 x d1400	4000 mm 157.5 in	1400 mm 55 in	730 mm 28.5 in	705 mm 28 in	410 mm 16 in	615 mm 24 in	3545 mm 139.5 in	175 kg 386 lb	
NOMSDG344									
Morse Work Table w4400 x d1400	4400 mm 173 in	1400 mm 55 in	730 mm 28.5 in	705 mm 28 in	410 mm 16 in	615 mm 24 in	3945 mm 155.5 in	180 kg 397 lb	
NOMSDG348									
Morse Work Table w4800 x d1400	4800 mm 189 in	1400 mm 55 in	730 mm 28.5 in	705 mm 28 in	410 mm 16 in	615 mm 24 in	4345 mm 171 in	203.5 kg 448.5 lb	
NOMSDG356									
Morse Work Table w5600 x d1400	5600 mm 220.5 in	1400 mm 55 in	730 mm 28.5 in	705 mm 28 in	410 mm 16 in	615 mm 24 in	5145 mm 202.5 in	231.5 kg 510.5 lb	
NOMSDG364									
Morse Work Table w6400 x d1400	6400 mm 252 in	1400 mm 55 in	730 mm 28.5 in	705 mm 28 in	410 mm 16 in	615 mm 24 in	5945 mm 234 in	260 kg 573.5 lb	

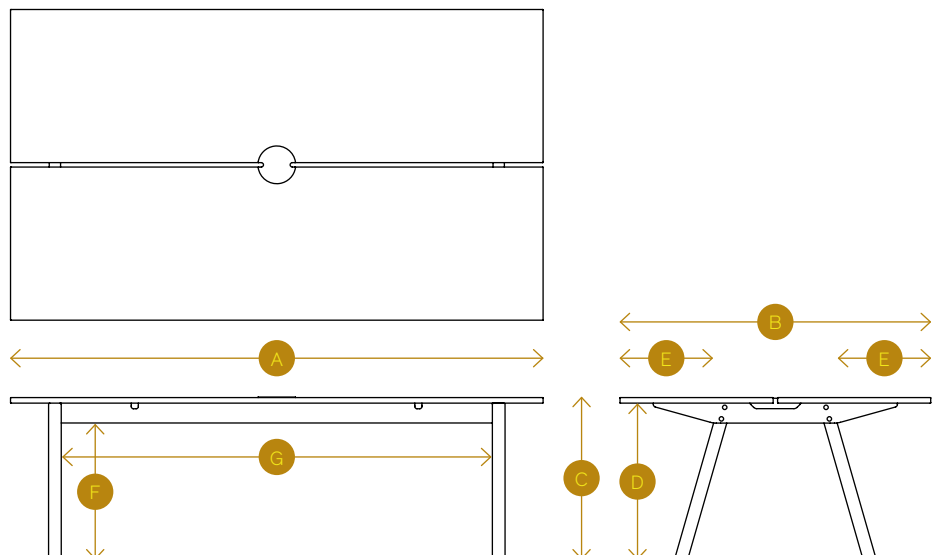
Measuring Guide





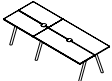
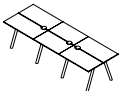
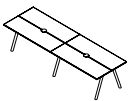
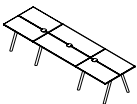
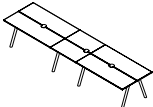
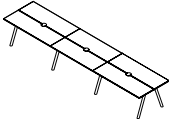

Bar Height Work Tables depth 1400 mm / 55 in

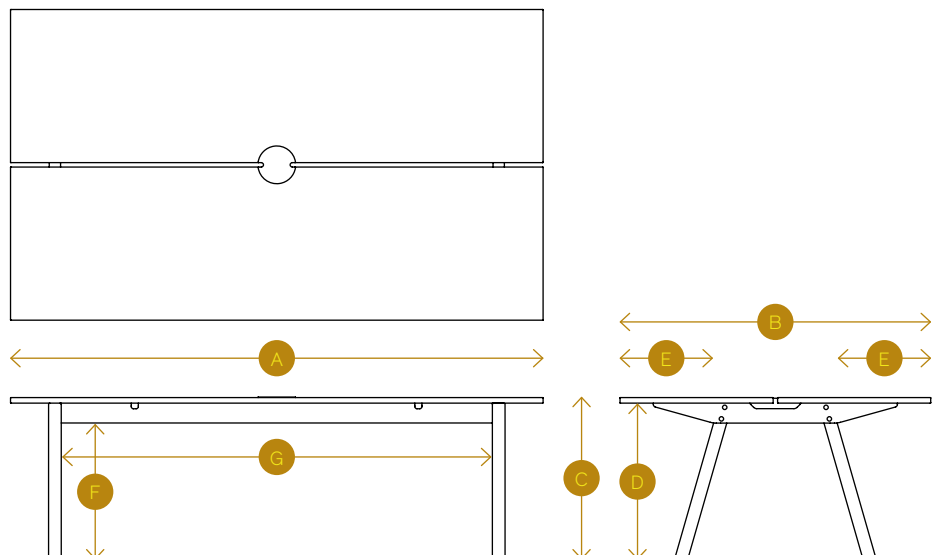
PRODUCT CODE/ DESCRIPTION	A OVERALL WIDTH	B OVERALL DEPTH	C OVERALL HEIGHT	D FLOOR TO TABLE TOP	E FRONT OF TOP TO BEAM	F FLOOR TO BEAM	G DISTANCE BETWEEN LEGS	H WEIGHT	I CAD
NOMSDC516									
Morse Bar Height Work Table w1600 x d1400	1600 mm 63 in	1400 mm 55 in	1050 mm 41.5 in	1025 mm 40.5 in	410 mm 16 in	935 mm 37 in	1145 mm 45 in	75 kg 165.5 in	
NOMSDC524									
Morse Bar Height Work Table w2400 x d1400	2400 mm 94.5 in	1400 mm 55 in	1050 mm 41.5 in	1025 mm 40.5 in	410 mm 16 in	935 mm 37 in	1945 mm 76.5 in	103.5 kg 228 in	
NOMSDG528									
Morse Bar Height Work Table w2800 x d1400	2800 mm 110 in	1400 mm 55 in	1050 mm 41.5 in	1025 mm 40.5 in	410 mm 16 in	935 mm 37 in	2345 mm 92.5 in	129 kg 284.5 in	
NOMSDG536									
Morse Bar Height Work Table w3600 x d1400	3600 mm 141.5 in	1400 mm 55 in	1050 mm 41.5 in	1025 mm 40.5 in	410 mm 16 in	935 mm 37 in	3145 mm 124 in	157 kg 346 in	
NOMSDG540									
Morse Bar Height Work Table w4000 x d1400	4000 mm 157.5 in	1400 mm 55 in	1050 mm 41.5 in	1025 mm 40.5 in	410 mm 16 in	935 mm 37 in	3545 mm 139.5 in	182.5 kg 402.5 in	
NOMSDG544									
Morse Bar Height Work Table w4400 x d1400	4400 mm 173 in	1400 mm 55 in	1050 mm 41.5 in	1025 mm 40.5 in	410 mm 16 in	935 mm 37 in	3945 mm 155.5 in	185 kg 408 in	
NOMSDG548									
Morse Bar Height Work Table w4800 x d1400	4800 mm 189 in	1400 mm 55 in	1050 mm 41.5 in	1025 mm 40.5 in	410 mm 16 in	935 mm 37 in	4345 mm 171 in	210.5 kg 464 in	
NOMSDG556									
Morse Bar Height Work Table w5600 x d1400	5600 mm 220.5 in	1400 mm 55 in	1050 mm 41.5 in	1025 mm 40.5 in	410 mm 16 in	935 mm 37 in	5145 mm 202.5 in	239 kg 527 in	
NOMSDG564									
Morse Bar Height Work Table w6400 x d1400	6400 mm 252 in	1400 mm 55 in	1050 mm 41.5 in	1025 mm 40.5 in	410 mm 16 in	935 mm 37 in	5945 mm 234 in	267 kg 588.5 in	

Measuring Guide





Curves depth 800 mm / 31.5in

PRODUCT CODE/ DESCRIPTION	A OVERALL WIDTH	B OVERALL DEPTH	C OVERALL HEIGHT	D TABLE DEPTH	E FLOOR TO TABLE TOP	F CORNER ANGLE	G WEIGHT	H CAD
MSAU903SQ								
Table Section 90° Curve Square d800	1000 mm 39.5 in	1000 mm 39.5 in	730 mm 28.5 in	800 mm 31.5 in	705 mm 28 in	90°	30.5 kg 67.5 lb	
MSAU903RD								
Table Section 90° Curve Round d800	1000 mm 39.5 in	1000 mm 39.5 in	730 mm 28.5 in	800 mm 31.5 in	705 mm 28 in	90°	29.5 kg 65 lb	
MSAU905SQ								
Bar Height Table Section 90° Curve Square d800	1000 mm 39.5 in	1000 mm 39.5 in	1050 mm 41.5 in	800 mm 31.5 in	1025 mm 40.5 in	90°	33 kg 73 lb	
MSAU905RD								
Bar Height Table Section 90° Curve Round d800	1000 mm 39.5 in	1000 mm 39.5 in	1050 mm 41.5 in	800 mm 31.5 in	1025 mm 40.5 in	90°	32.5 kg 71.5 lb	

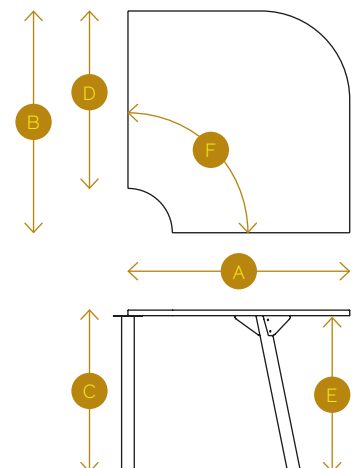
Measuring Guide

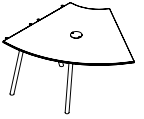

Curves depth 1400 mm / 55in

PRODUCT CODE/ DESCRIPTION	A OVERALL WIDTH	B OVERALL DEPTH	C OVERALL HEIGHT	D TABLE DEPTH	E FLOOR TO TABLE TOP	F CORNER ANGLE	G WEIGHT	H CAD
MSAU903SQ								
Table Section 30° Curve d1400	1000 mm 39.5 in	1480 mm 58.5 in	730 mm 28.5 in	1400 mm 55 in	705 mm 28 in	30°	30 kg 66 lb	
MSAU903RD								
Table Section 60° Curve d1400	1700 mm 67 in	1730 mm 68 in	730 mm 28.5 in	1400 mm 55 in	705 mm 28 in	60°	52.5 kg 116 lb	
MSAU905SQ								
Bar Height Table Section 30° Curve d1400	1000 mm 39.5 in	1480 mm 58.5 in	1050 mm 41.5 in	1400 mm 55 in	1025 mm 40.5 in	30°	31.5 kg 69.5 lb	
MSAU905RD								
Bar Height Table Section 60° Curve d1400	1700 mm 67 in	1730 mm 68 in	1050 mm 41.5 in	1400 mm 55 in	1025 mm 40.5 in	60°	55 kg 121.5 lb	

Measuring Guide

